

**EchoLife ONT GPON Terminal
HG8245H
Product Description**

Issue **01**
Date **2013-05-20**

Copyright © Huawei Technologies Co., Ltd. 2013. All rights reserved.

No part of this document may be reproduced or transmitted in any form or by any means without prior written consent of Huawei Technologies Co., Ltd.

Trademarks and Permissions



and other Huawei trademarks are trademarks of Huawei Technologies Co., Ltd.

All other trademarks and trade names mentioned in this document are the property of their respective holders.

Notice

The purchased products, services and features are stipulated by the contract made between Huawei and the customer. All or part of the products, services and features described in this document may not be within the purchase scope or the usage scope. Unless otherwise specified in the contract, all statements, information, and recommendations in this document are provided "AS IS" without warranties, guarantees or representations of any kind, either express or implied.

The information in this document is subject to change without notice. Every effort has been made in the preparation of this document to ensure accuracy of the contents, but all statements, information, and recommendations in this document do not constitute a warranty of any kind, express or implied.

Huawei Technologies Co., Ltd.

Address: Huawei Industrial Base
Bantian, Longgang
Shenzhen 518129
People's Republic of China

Website: <http://www.huawei.com>

Email: support@huawei.com





About This Document

Overview

GPON terminal EchoLife ONT is an indoor optical network terminal (ONT) designed for home users. This document provides the appearance, key features, and technical specifications of the ONT, which helps you know the ONT quickly.

Symbol Conventions

The following symbols may be found in this document. They are defined as follows:

Symbol	Description
 DANGER	DANGER indicates a hazard with a high level or medium level of risk which, if not avoided, could result in death or serious injury.
 WARNING	WARNING indicates a hazard with a low level of risk which, if not avoided, could result in minor or moderate injury.
 CAUTION	CAUTION indicates a potentially hazardous situation that, if not avoided, could result equipment damage, data loss, performance degradation, or unexpected results.
 TIP	Indicates a tip that may help you solve a problem or save your time.
 NOTE	Provides additional information to emphasize or supplement important points of the main text.

Contents

About This Document	ii
1 About This Document	4
2 Introduction	5
2.1 Product Positioning	5
2.2 Network Applications.....	5
2.3 Product Overview.....	6
3 Product Functions and Features	13
4 Product Highlights	15
4.1 Comprehensive Triple Play Service	15
4.2 Secure and Reliable Wi-Fi Access.....	16
4.3 Convenient Home Network Attached Storage and File Sharing Services.....	17
4.4 Secure and Powerful Gateway Functions.....	18
4.5 Convenient Automatic Provisioning, Maintenance, and Management of the Remote Service	18
5 Port Specifications	19
5.1 GPON Port Specifications.....	19
5.2 GE Port Specifications	20
5.3 POTS port	20
5.4 USB Port	21
5.5 Wireless Network Access	21
6 Acronyms and Abbreviations	22





1 About This Document

Overview

GPON terminal EchoLife ONT is an indoor optical network terminal (ONT) designed for home users. This document provides the appearance, key features, and technical specifications of the ONT, which helps you know the ONT quickly.

Symbol Conventions

The following symbols may be found in this document. They are defined as follows:

Symbol	Description
 DANGER	DANGER indicates a hazard with a high level or medium level of risk which, if not avoided, could result in death or serious injury.
 WARNING	WARNING indicates a hazard with a low level of risk which, if not avoided, could result in minor or moderate injury.
 CAUTION	CAUTION indicates a potentially hazardous situation that, if not avoided, could result equipment damage, data loss, performance degradation, or unexpected results.
 TIP	Indicates a tip that may help you solve a problem or save your time.
 NOTE	Provides additional information to emphasize or supplement important points of the main text.

2 Introduction

- [2.1 Product Positioning](#)
- [2.2 Network Applications](#)
- [2.3 Product Overview](#)

2.1 Product Positioning

EchoLife GPON terminal HG8245H is an indoor optical network terminal (ONT) designed for home users. Its upper shell adopts the natural heat dissipation material, and its optical port adopts the dust-proof design with a rubber plug. The ONT is eye-pleasing and energy-efficient. It can be deployed on a workbench or mounted on a wall, meeting users' deployment requirements in different scenarios.

The ONT provides the more convenient and efficient remote management function. It supports the TR-069 and ONT Management and Control Interface (OMCI) protocols and manages all home terminals in a unified manner, implementing remote fault diagnosis, service provisioning, and performance statistics.

By using the Gigabit-capable Passive Optical Network (GPON) technology, the ONT provides a high-speed data channel through a single optical fiber with an upstream rate of 1.244 Gbit/s and a downstream rate of 2.488 Gbit/s. In this way, you can enjoy the high-speed data service, quality voice service, and superior video service. Apart from that, you can also enjoy the secure and reliable wireless access service and the convenient home network attached storage and file sharing services.

2.2 Network Applications

As a network terminal, the ONT is deployed at the GPON access layer and connects the home users users to the Internet through the optical upstream port.

[Figure 2-1](#) shows the position of the ONT on a network.

Figure 2-1 Network topology of the ONT

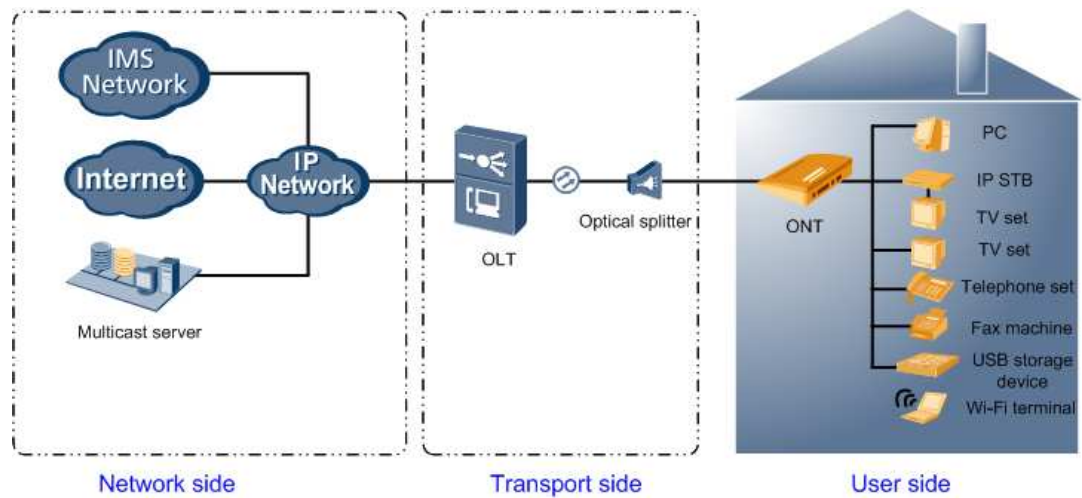

- In the upstream direction, the ONT is connected to the optical splitter and the networkside OLT through the passive optical network (PON) port, namely the OPTICAL port, to provide the integrated access service.
- In the downstream direction, the ONT is connected to various terminals through the abundant LAN-side ports, implementing the triple play service.
 - Ethernet ports, which can be connected to terminals such as the PC, STB, and video phone to provide the high-speed data and video services.



NOTE

Each Ethernet port allows only 1 user access.

- TEL ports, which can be connected to the telephone set or fax machine to provide the superior and cost-effective voice over IP (VoIP), fax over IP (FoIP), and modem over IP (MoIP) services.



NOTE

Each TEL port allows only 1 user access.

- Wi-Fi, which can be connected to a Wi-Fi terminal through wireless connection to provide a secure and reliable high-speed wireless network.



NOTE

Each ONT allows up 6 wireless connections.

- USB port, which can be connected to a USB storage device to provide convenient home network attached storage and file sharing services.

2.3 Product Overview

Introduced the appearance, interfaces, LEDs and device parameters of the HG8245H.

Appearance

Figure 2-2 Appearance of the HG8245H

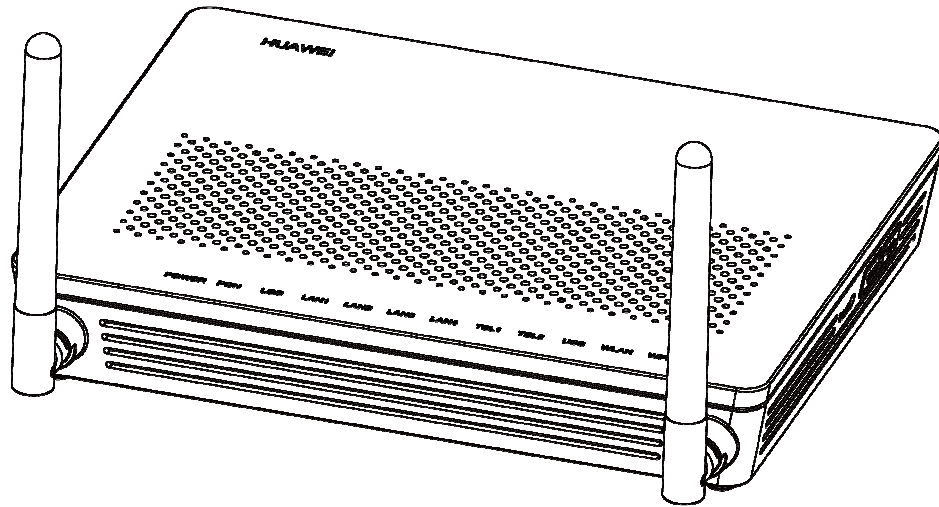

Port/Button

Figure 2-13 and Figure 2-14 show the ports on the rear panel and side panel of the HG8245H respectively.

Figure 2-3 Ports and buttons on the rear panel of the HG8245H

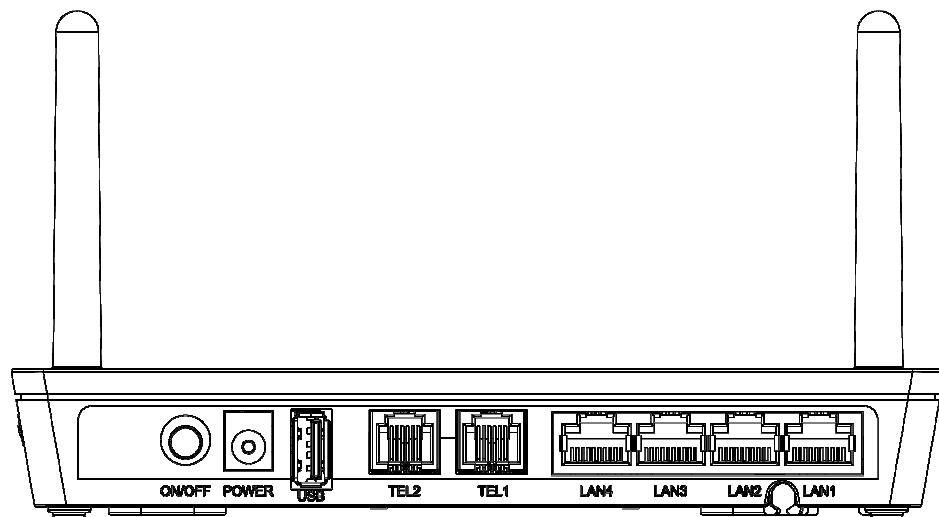

Table 2-1 Description of ports and buttons on the rear panel of the HG8245H

Port/Button	Function
ON/OFF	Indicates the power button. It is used to power on or power off the device.

Port/Button	Function
POWER	Indicates the power port, used to connect to the power adapter or backup battery unit.
USB	Indicate USB host ports, used to connect to USB storage devices.
TEL1-TEL2	Indicate VoIP telephone ports (RJ-11), used for connecting to the ports on telephone sets.
LAN1-LAN4	Indicate auto-sensing 10/100/1000M Base-T Ethernet ports (RJ-45), used to connect to PCs or IP set-top boxes (STBs).

Figure 2-4 Ports and buttons on the side cover of the HG8245H

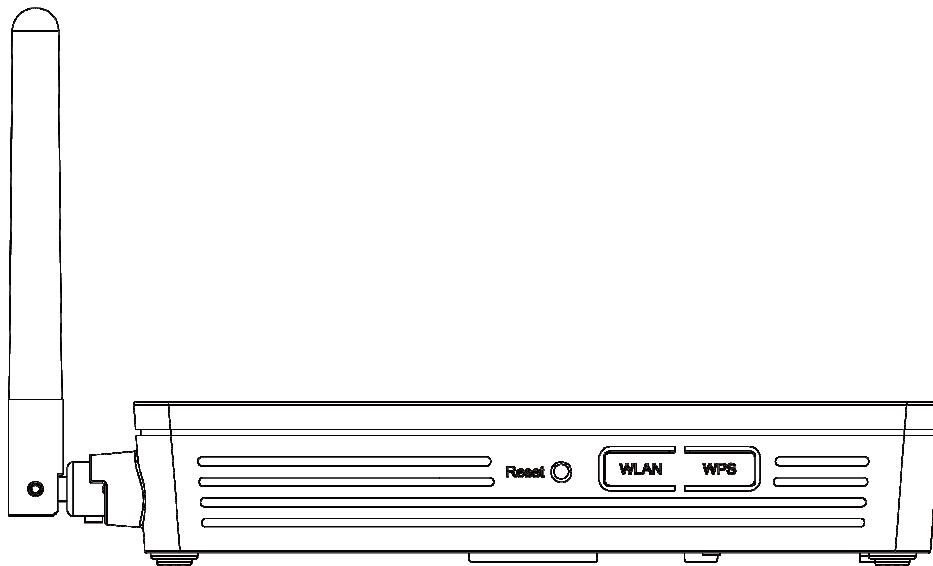

Table 2-2 Description of ports and buttons on the side cover of the HG8245H

Port/Button	Function
Reset	Indicates the reset button. Press the button for a short time to reset the device; press the button for a long time (longer than 10s) to restore the device to the default settings and reset the device.
WLAN	Indicates the WLAN button, used to enable or disable the WLAN function.
WPS	Indicates the WLAN data encryption switch.

Figure 2-15 shows optical ports on the HG8245H.

Figure 2-5 Optical ports on the HG8245H

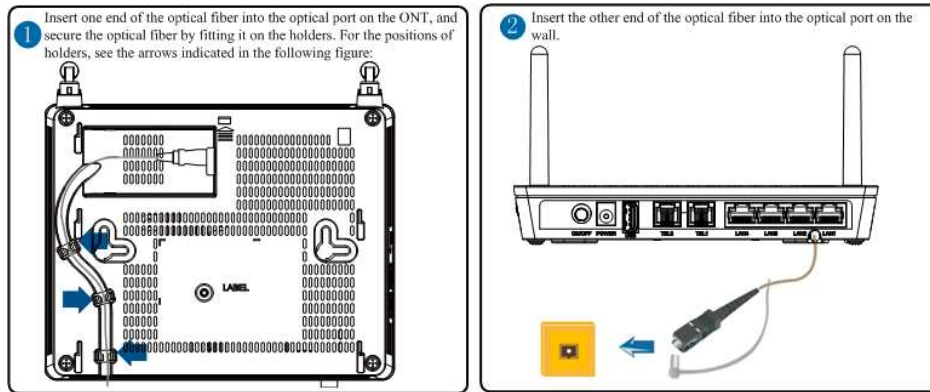

Table 2-3 Description of optical ports on the HG8245H

Port/Button	Function
OPTICAL	<p>Indicates an optical port. The optical port is equipped with a rubber plug and is connected to an optical fiber for upstream transmission.</p> <p>The type of the optical connector connected to the OPTICAL port is SC/APC.</p>

LEDs

Figure 2-6 LEDs on the HG8245H

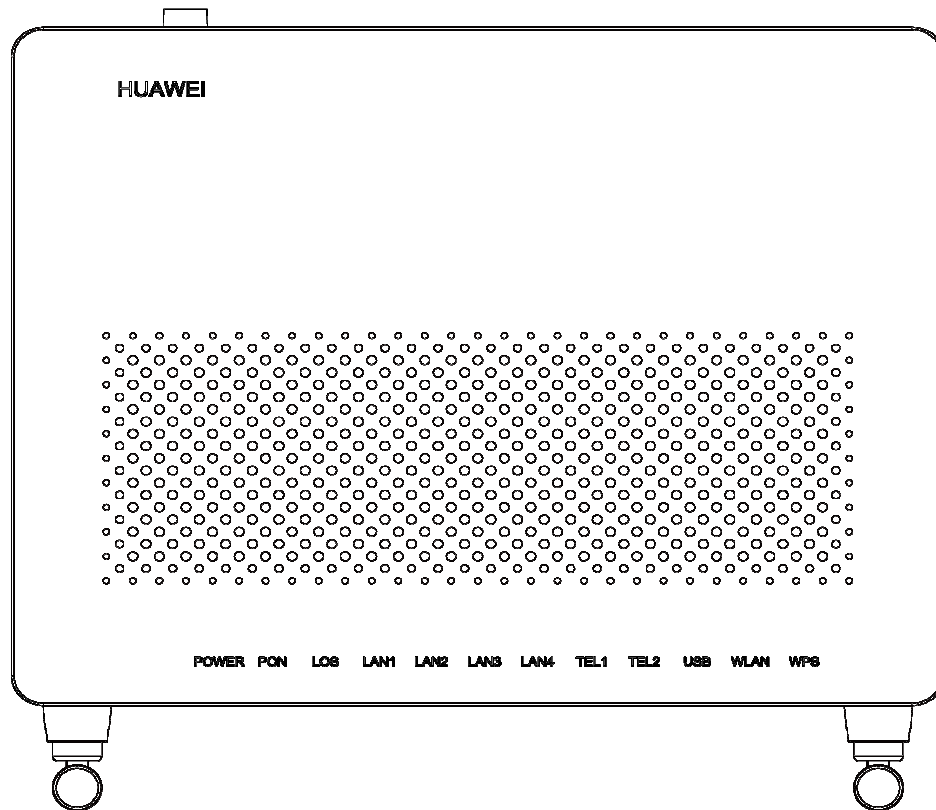

Table 2-4 Indications of the LEDs on the HG8245H

LED	Description	Status	Description
POWER	Power supply LED	Always on	The device is powered on.
		Off	The power supply is cut off.
PON	Authentication LED	See Table 2-17 .	
LOS	Connection LED	See Table 2-17 .	
LAN1–LAN4	Ethernet port LED	Always on	The Ethernet connection is in the normal state.
		Blinking	Data is being transmitted on the Ethernet port.
		Off	The Ethernet connection is not set up.
TEL1–TEL2	Voice telephone port	Always on	The HG8245H is registered with the softswitch but no service

LED	Description	Status	Description
	LED		flows are transmitted.
		Blinking	Service flows are transmitted.
		Off	The HG8245H is not powered on or fails to be registered to the softswitch.
USB	USB port LED	Always on	The USB port is connected and is working in the host mode, but no data is transmitted.
		Blinks quickly (twice per second)	Data is being transmitted on the USB port.
		Off	The system is not powered on or the USB port is not connected.
WLAN	WLAN LED	Always on	The WLAN function is enabled.
		Blinking	Data is being transmitted on the WLAN port.
		Off	The WLAN function is disabled.
WPS	WPS LED	Always on	The WPS function is enabled.
		Blinking	A Wi-Fi terminal is accessing the system.
		Off	The WPS function is disabled.

Table 2-5 Indications of the PON and LOS LEDs

No.	LED Status		Description
	PON	LOS	
1	Off	Off	The ONT is disabled by the OLT.
2	Blinks quickly (twice per second)	Off	The ONT is attempting to set up a connection to the OLT.
3	Always on	Off	The connection between the ONT and the OLT is set up.
4	Off	Blinks slowly (once two seconds)	The Rx optical power of the ONT is lower than the optical receiver sensitivity. The ONT is not connected to optical fibers or does not send optical signals.
5	Blinks quickly (twice per	Blinks quickly (twice per	The OLT detects that the device

No.	LED Status		Description
	PON	LOS	
	second)	second)	is a rogue ONT.
6	Blinks quickly (twice per second)	Blinks slowly (once two seconds)	The Rx optical power of the ONT does not within the range (-27 dBm to -8 dBm) of the Rx sensitivity.

Device parameters

The device parameters include the ONT's size, weight, operating environment, and power parameters and equipment power consumption.

Table 2-6 HG8245H device parameters

Parameter	Specifications
Dimensions (length x width x height)	176 mm x 138.5 mm x 28 mm
Weight	About 500 g
Working environment	Operating temperature: 0°C to +40°C
	Environment humidity: 5% RH to 95% RH (non-condensing)
	Pressure environment: 86 kPa to 106 kPa
	Altitude: 2000 m
Power specifications	Power adapter input: 100–240 V AC, 50–60 Hz
	System power supply: 11–14 V DC, 2 A
Power consumption	<ul style="list-style-type: none"> Static power: 5 W Maximum power consumption: 15.5 W

3 Product Functions and Features

This chapter describes the key characteristics of the HG8245H.

Type	Features
GPON features	<ul style="list-style-type: none"> • Class B+ optical power budget • Authentication modes of SN, password, and SN+password
Gateway features	<ul style="list-style-type: none"> • NAT • Internet, IPTV and VoIP services automatically bound to the ONT port • Virtual Server, Port Trigger • Port trigger and DMZ
Broadband features	<ul style="list-style-type: none"> • Any port any service • Smart pipe • Intelligent hotspot
Voice features	<ul style="list-style-type: none"> • Session Initiation Protocol (SIP), H.248 • Voice media streams and signaling streams separation
Multicast features	<ul style="list-style-type: none"> • IGMP V2&V3 Snooping • Dynamically controllable multicast • IGMP Proxy
Security features	<ul style="list-style-type: none"> • MAC address filtering, IP address filtering, URL address filtering • Anti-DoS
Device maintenance	<ul style="list-style-type: none"> • Local service configuration, query, and software upgrade on the Web page • Automatic remote service provisioning, device management, and software upgrade through OMCI • Query of the information about the ONT optical transceiver

Type	Features
	<ul style="list-style-type: none">• Loop line test and circuit test• Dual system protection of the software (normal system and mini system)• Intelligent monitoring
Reliable features	<ul style="list-style-type: none">• Dual system protection of the software (normal system and mini system)
Ethernet features	<ul style="list-style-type: none">• VLAN filtering, VLAN transparent transmission• VLAN N:1 aggregation and VLAN 1:1 switch
Power-saving features	<ul style="list-style-type: none">• Dynamic power adjustment



NOTE

For details about the features, see the *Feature Description*.

4 Product Highlights

4.1 Comprehensive Triple Play Service

On the LAN side, the ONT provides abundant hardware ports to implement multiple access services, including the home network attached storage, Internet access, voice, and video services, providing users with the comprehensive triple play service.

4.2 Secure and Reliable Wi-Fi Access

The ONT helps users build a secure and reliable wireless network based on the 802.11 b/g/n Wi-Fi access.

4.3 Convenient Home Network Attached Storage and File Sharing Services

The ONT provides one USB port, which can be used to connect to a USB storage device to provide convenient home network attached storage and file sharing services.

4.4 Secure and Powerful Gateway Functions

The ONT can function as a home gateway, which features the secure and powerful gateway functions.

4.5 Convenient Automatic Provisioning, Maintenance, and Management of the Remote Service

The ONT applies the TR-069 and OMCI management, manages terminal services without additional IP networks, which facilitates automatic provisioning, maintenance, and management of the remote service.

4.1 Comprehensive Triple Play Service

On the LAN side, the ONT provides abundant hardware ports to implement multiple access services, including the home network attached storage, Internet access, voice, and video services, providing users with the comprehensive triple play service.

Figure 4-1 Comprehensive Triple Play Service

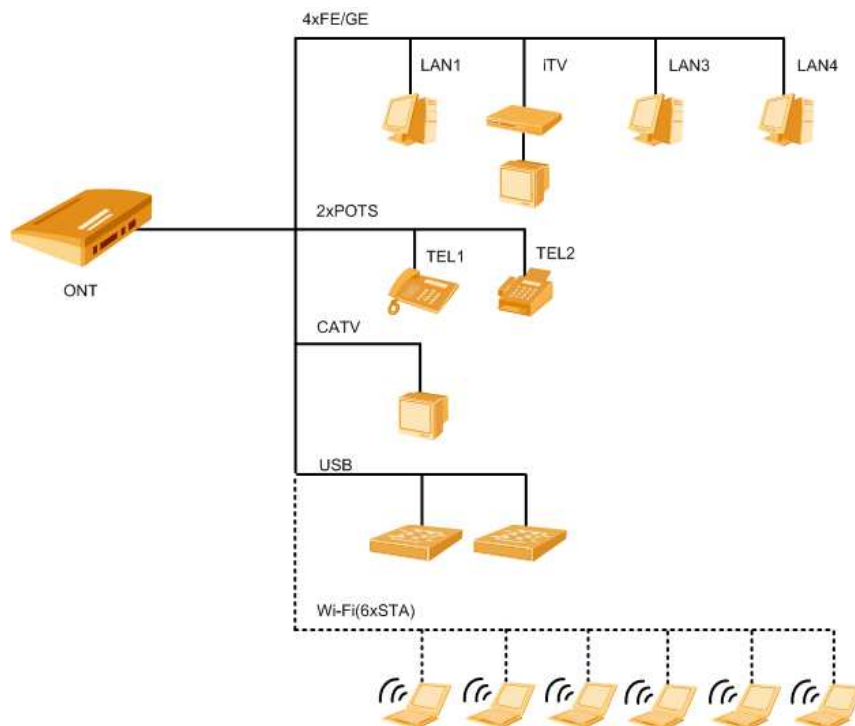

NOTE

- Each Ethernet port allows only 1 user access.
- Each TEL port allows only 1 user access.
- Each ONT allows up to 6 wireless connections.

4.2 Secure and Reliable Wi-Fi Access

The ONT helps users build a secure and reliable wireless network based on the 802.11 b/g/n Wi-Fi access.

Figure 4-2 Wi-Fi Access



The Wi-Fi access of the ONT has the following features:

- Supports four SSIDs. The user can select different wireless networks by setting different SSIDs.
- Compatible with IEEE 802.11b/802.11g/802.11n, passing the authentication of Wireless Fidelity (Wi-Fi) Alliance and featuring good compatibility with other WLAN devices.
- Supports multiple authentication and encryption modes, providing users with the secure and reliable wireless access.

4.3 Convenient Home Network Attached Storage and File Sharing Services

The ONT provides one USB port, which can be used to connect to a USB storage device to provide convenient home network attached storage and file sharing services.

The USB storage function of the ONT has the following features:

- The USB port supports Universal Plug and Play (UPnP) and hot plugging.
- The USB function can be configured on the local Web page, which facilitates home network attached file sharing.
- The USB port implements the FTP client for home storage, that is, downloading files from the FTP server in a public network to the USB storage device.

4.4 Secure and Powerful Gateway Functions

The ONT can function as a home gateway, which features the secure and powerful gateway functions.

The gateway features of the ONT are as follows:

- Forwarding rate up to 900 Mbit/s, meeting service requirements for a high quality.
- Functioning as a DHCP server or a DHCP client, meeting various requirements in different scenarios.
- Configuration of anti-DoS attack, MAC address filtering, IP address filtering, URL address filtering, firewall, and ONT ACL, making the ONT more secure and reliable when it functions as a gateway.

4.5 Convenient Automatic Provisioning, Maintenance, and Management of the Remote Service

The ONT applies the TR-069 and OMCI management, manages terminal services without additional IP networks, which facilitates automatic provisioning, maintenance, and management of the remote service.

The remote service management of the ONT has the following features:

- Supports configuring the global profile and issuing the XML configuration file on the NMS. To provision ONT services in batches and adjust the network, only a few changes are required.
- Supports user-defined upgrade policies configured through the NMS. The device is automatically upgraded after being powered on and no manual operation is required.
- Supports remote performance management of the ONT through the NMS. By collecting the performance data, the network performance exception can be monitored in real time.
- Supports remote fault locating of the ONT through the NMS. Through alarm reporting and remote loopback diagnosis, the fault can be located remotely, which decreases the maintenance cost.

5 Port Specifications

Introduced the interface indicators parameter of the ONT.

5.1 GPON Port Specifications

Introduced the GPON interfaces indicators of the ONT.

5.2 GE Port Specifications

This topic describes the specifications and standards compliance of Gigabit Ethernet (GE) ports.

5.3 POTS port

This section describes the specifications and standards for the plain old telephone service (POTS) port supported by the ONT.

5.4 USB Port

This topic introduces the specifications of the USB port on the ONT.

5.5 Wireless Network Access

This topic introduces the wireless network access indicators of the ONT.

5.1 GPON Port Specifications

Introduced the GPON interfaces indicators of the ONT.

Table 5-1 GPON port specifications

Parameter	Specifications
Transmission rate	Rx: 2.488 Gbit/s Tx: 1.244 Gbit/s
Connector	SC/APC
Maximum reach	20 km
Standard compliance	ITU-T G.984.2 CLASS B+
Center wavelength	Tx: 1310 nm

Parameter	Specifications
	Rx: 1490 nm
Tx optical power	0.5 dBm to 5.0 dBm
Extinction ratio	> 10 dB
Minimum receiver sensitivity	-27 dBm
Maximum overload optical power	-8 dBm

5.2 GE Port Specifications

This topic describes the specifications and standards compliance of Gigabit Ethernet (GE) ports.

Table 5-2 Specifications of a GE port

Parameter	Specifications
Connector type	RJ45
Port rate	10 Mbit/s, 100 Mbit/s, or 1000 Mbit/s
Maximum transmission distance	100 m
Working mode	Auto-adaptive 10 Mbit/s, 100 Mbit/s or 1000 Mbit/s
Cable specifications	Category 5 UTP
Compliant standard	IEEE 802.3i IEEE 802.3u IEEE 802.3ab

5.3 POTS port

This section describes the specifications and standards for the plain old telephone service (POTS) port supported by the ONT.

Table 5-3 POTS Port Specifications

Parameter	Specifications
Connector type	RJ11
Transmission rate	64 kbit/s
Cable type	Twisted pair

Parameter	Specifications
Line coding	Pulse code modulation (PCM)
Frame protocol	Time division multiplexing (TDM)
Standard compliance	ITU-T Q.551 ITU-T Q.552

5.4 USB Port

This topic introduces the specifications of the USB port on the ONT.

Table 5-4 Specifications of the USB port

Parameter	Specification
Transmission rate	480 Mbit/s
Support type	USB 2.0 HOST and USB 1.1

5.5 Wireless Network Access

This topic introduces the wireless network access indicators of the ONT.

Table 5-5 Wireless network access indicators

Parameter	Indicator
Standards compliance	802.11b/g/n
Specification	<ul style="list-style-type: none"> • 4 SSIDs • 13 working channels • Automatic rate adjustment • Transmit power adjustment
Authentication	Open system and shared key
Encryption	<ul style="list-style-type: none"> • 64-bit and 128-bit WEP encryption • WPA-PSK, WPA2-PSK, WPA, WPA2, AES, and TKIP

6 Acronyms and Abbreviations

A

AES Advanced Encryption Standard

ALG Application Level Gateway

B

BRAS Broadband Remote Access Server

C

CATV Community Antenna Television

D

DBA Dynamic Bandwidth Assignment

DHCP Dynamic Host Configuration Protocol

DMZ Demilitarized Zone

DNS Domain Name Server

DTMF Dual Tone Multi-Frequency

DoS Denial of Service

F

FEC Forward Error Correction

FoIP FAX over IP

FTTH Fiber To The Home

G

GPON Gigabit-capable Passive Optical Network

I

IGMP Internet Group Management Protocol

M

MoIP Modem over IP

N

NAPT	Network Address and Port Translation
NAT	Network Address Translation
NMS	Network Management System

O

OAM	Operations, Administration, and Maintenance
OLT	Optical Line Terminal
OMCI	Optical Network Termination Management and Control Interface
ONT	Optical Network Terminal

P

PLOAM	Physical Layer OAM
PON	Passive Optical Network
PSTN	Public Switched Telephone Network

R

RTCP	Real-time Transport Control Protocol
RTP	Real-time Transport Protocol

S

SIP	Session Initiation Protocol
SSID	Service Set Identifier
STB	Set Top Box

T

TKIP	Temporal Key Integrity Protocol
-------------	---------------------------------

U

UPnP	Universal Plug and Play
-------------	-------------------------

V

VLAN	Virtual Local Area Network
VoIP	Voice over IP

W

WLAN	Wireless Local Area Network
WEP	Wired Equivalent Privacy
WPA	Wi-Fi Protected Access
WPS	Wi-Fi Protected Setup